



FLYING EYE

# User Manual

## Propeller Guards

DJI Matrice 350 RTK



*Made in France*



[www.flyingeye.fr](http://www.flyingeye.fr)



# Summary

Description	01
Content	02
Installation	03
User Guide	06
Precautions	07
Support & Warranty	08



# Propeller Guards

## DJI Matrice 350 RTK

### Description

Propeller guards for the DJI Matrice 350 RTK are essential safety accessories designed to protect the drone's propellers from collisions, while ensuring the safety of users and the environment during flight. They are particularly useful in confined environments or when the drone flies close to people, obstacles or delicate objects.

### Technical specifications :

- Dimensions: 40 x 50 x 10 cm
- Weight: approx. 440 g
- Materials: Nylon and Carbon
- Color: Black

***Quick assembly and disassembly without tools***

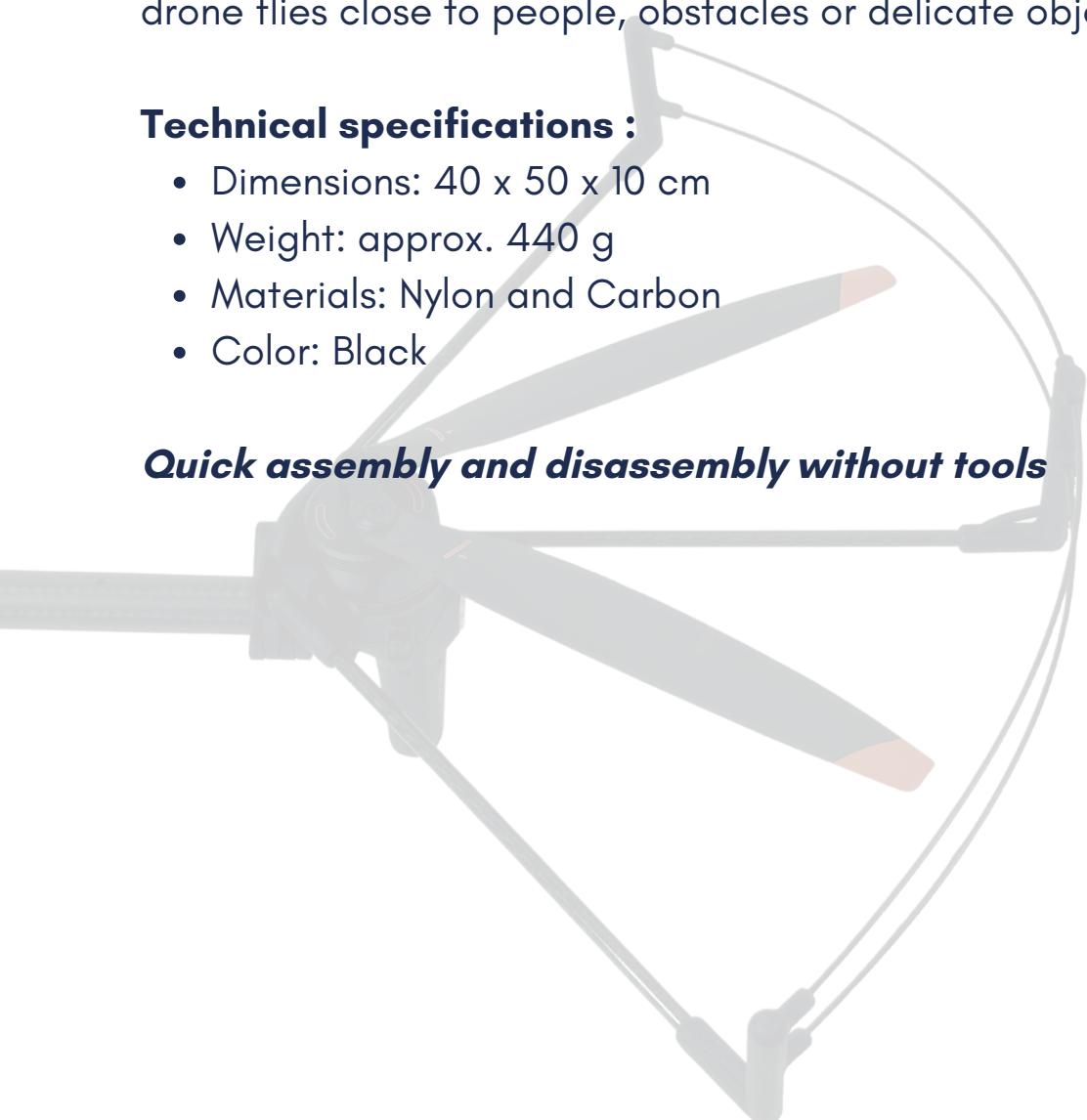



## Content

### Kit contents

- 4 x Propeller guards
- 4 x Mounting screws
- 1 x Installation manual

### Requirements

- **Compatibility:** This kit is specially designed for the DJI Matrice 350 RTK.
- Please ensure that you are using the correct accessories for this model of drone.
- **Propeller condition:** Before installing the guards, check the condition of the propellers. Replace any damaged propellers before fitting the guards, as damaged propellers can lead to flight problems.

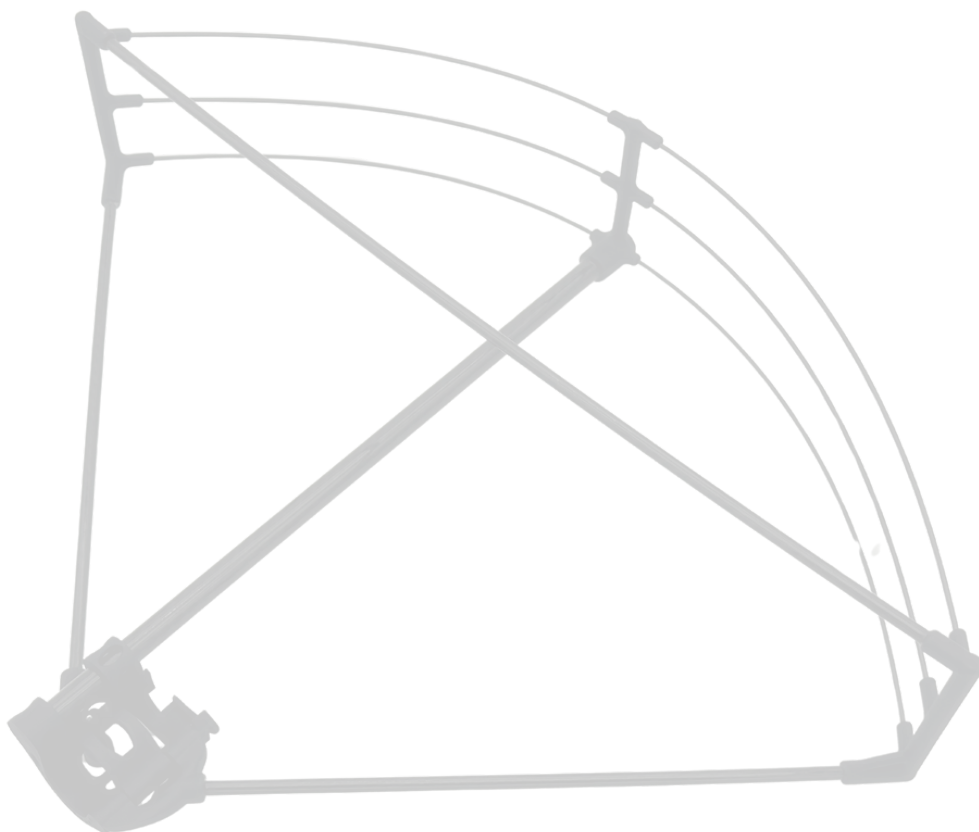



## Installation

### Preparing the drone:

- Make sure the drone is switched off and placed on a flat, stable surface.

### Fitting the guards:

- Please note that the direction of the propeller guards on the front and rear arms is different. Make sure you fit them in the correct direction.
- Securing the guards : Use the quick-fit systems to attach the propeller guards to each arm of the drone.
- Check tightening: Tighten the screws. Make sure the guards are firmly attached.

### Replace propellers:

- Check that each propeller rotates freely and that the guards do not interfere with their movement.



# Installation

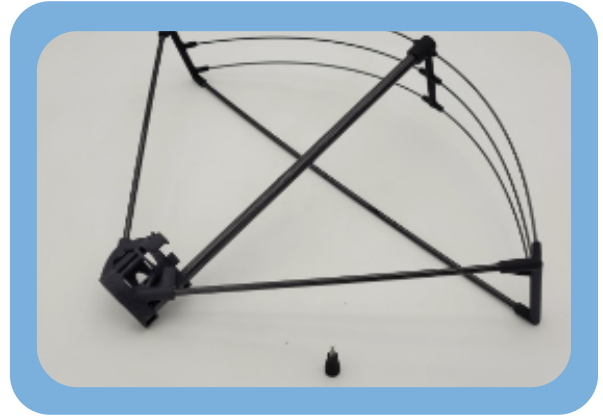

Unscrew



Turn the propeller guard over



Spread the base

## Installation

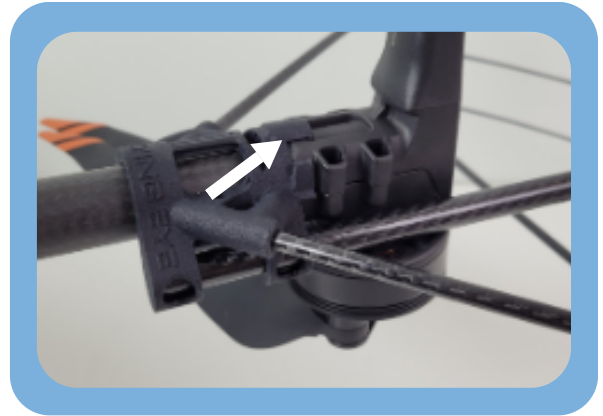

Insert the propeller guard all the way in, and tuck the hook into the motor part



Close the base



Screw



## User Guide

### **Pre-flight check:**

Before each flight, check that the propeller guards are securely fastened and show no cracks or signs of wear.

### **Maintenance and care**

#### *1. cleaning :*

After each flight, clean the propeller guards with a soft cloth to remove any accumulated dust or dirt. If flying in wet conditions, be sure to dry the guards thoroughly before storing.

#### *2. regular inspection :*

Inspect the protectors regularly for cracks, deformation or wear. If the protectors show signs of damage, replace them immediately to ensure optimum safety.

#### *3. storage :*

Store propeller guards in a dry place away from direct sunlight or extreme temperatures, which could damage them or alter their shape.

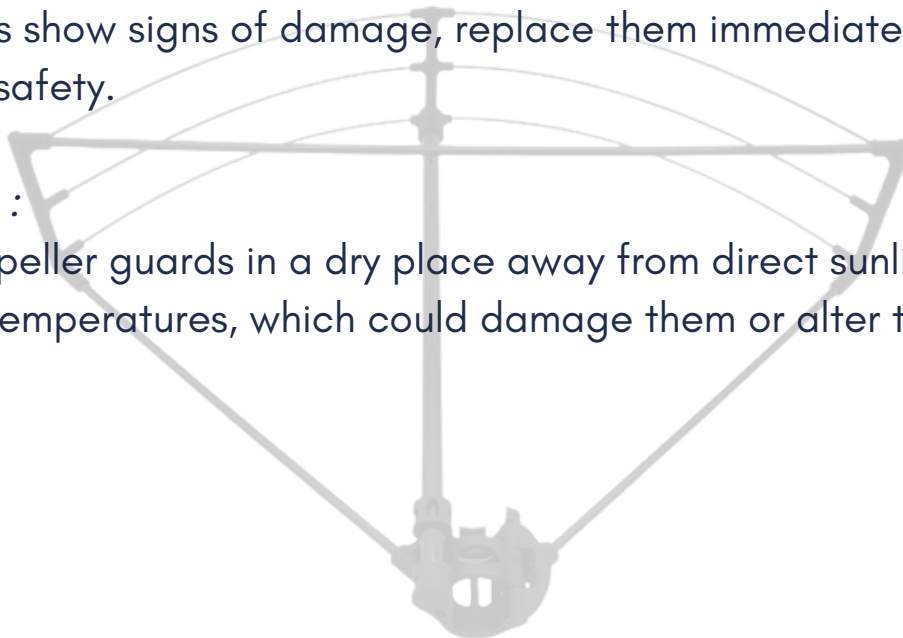



## Precautions

### Safety precautions

- **Reduced performance:** The addition of propeller guards can slightly affect the drone's flight performance, particularly flight time and battery consumption. Please take this into account when planning your missions.
- **Avoid high-speed flights:** Propeller guards can increase air resistance, especially at high speeds.
- **Watch for vibrations:** If you notice vibrations or instabilities during flight, land immediately and check that the propeller guards are secure and in good condition.

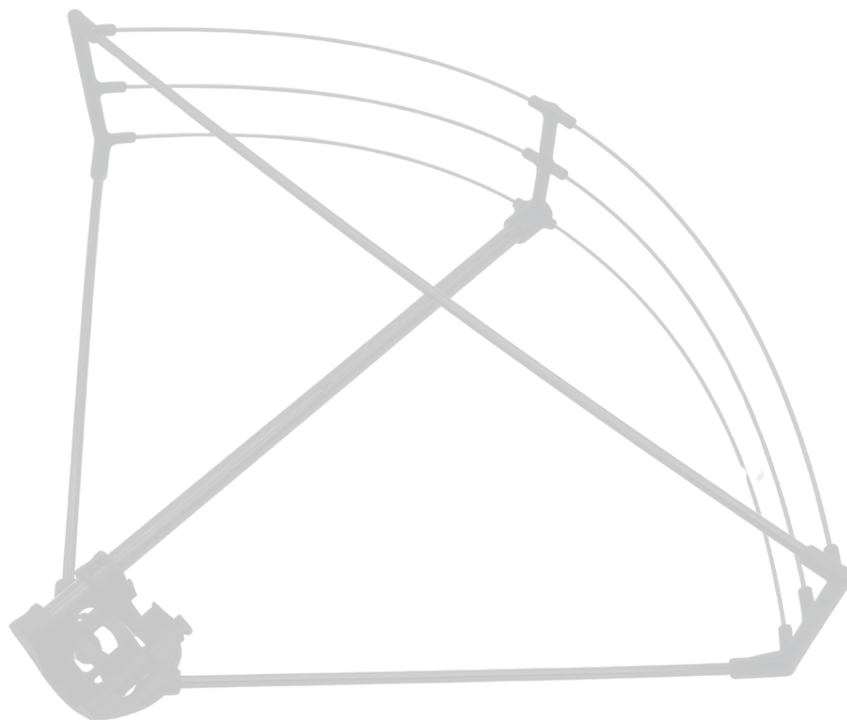



## Support & Warranty

### **Technical support**

If you encounter any difficulties during installation, or if you have any further questions about the use of propeller guards, please contact Flying Eye technical support.

### **Warranty**

Propeller guards for DJI Matrice 350 RTK come with a 12-month warranty according to the conditions of purchase. The warranty covers manufacturing defects, but does not apply to damage caused by incorrect installation, accident or improper use.

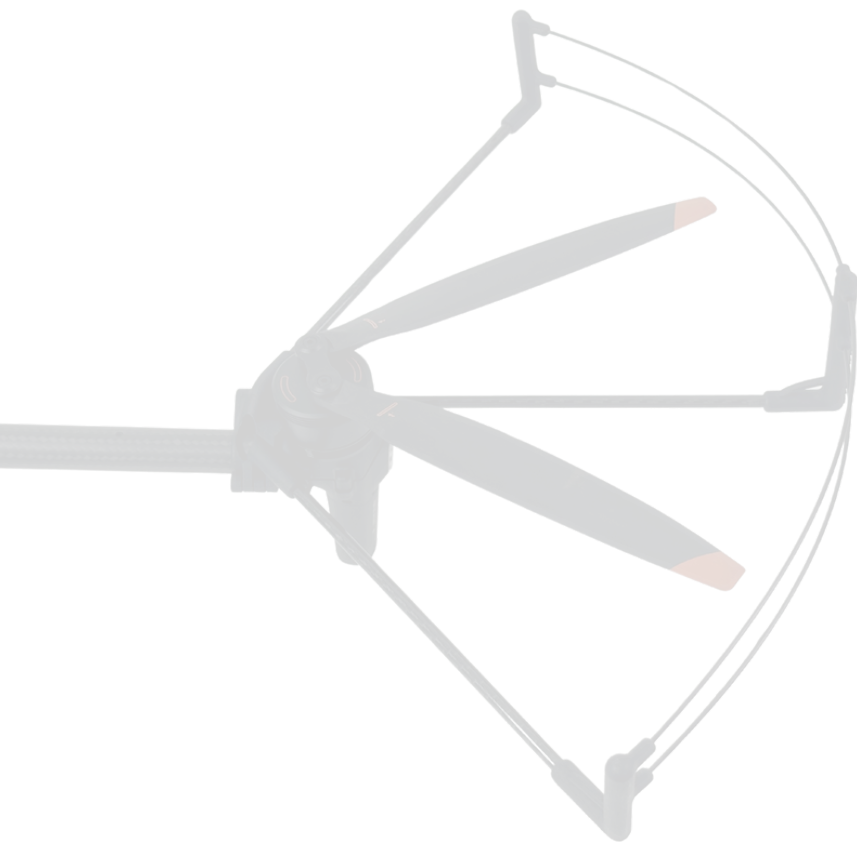



**FLYING EYE**

[WWW.FLYINGEYE.FR](http://WWW.FLYINGEYE.FR)

[INFO@FLYINGEYE.FR](mailto:INFO@FLYINGEYE.FR)

09.72.62.78.50

400 AVENUE ROUMANILLE  
GREEN SIDE - BATIMENT IB  
06410 BIOT / SOPHIA ANTIPOLIS